



## ELECTRIC RADIATORS

User and maintenance instructions

TYROOL V

CLAYSTEEL L

CLAYSTEEL S

FLEXY

SLIMMY



# **Congratulations!**

You are now the owner of the electric radiator made by Thermal Technology®.

Thermal Technology® electric radiators, distinguished by leading technology for a low power need, have a modern design combining particular electric properties of the carbon fiber and natural ceramics.

The following user and maintenance instructions have the aim to help You with correct radiator installation and maintenance, so we ask You to read it carefully and contact the assistance centre, if necessary.

## **ATTENTION**

Do not lose product identification code, in case you will need assistance, it will be requested by our assistance centre.

## CONTENT

1. Premises .....	4
2. Product identification .....	4
3. Package content.....	7
4. Safety cautions .....	7
4.1 Installation cautions.....	7
4.2 User cautions .....	14
5. User instructions .....	15
6. Maintenance and cleaning .....	21
7. Product recycling .....	21
8. Warning.....	19
9. Conformity .....	22
10. Warranty .....	23
11. Technical service .....	24

# 1. Premises

- The present user and maintenance instructions for Thermal Technology® radiator is a basic instrument for its correct utilization. Keep it in a dry and protected place for future reference.

# 2. Product identification

Electric radiator by Thermal Technology®	MODEL						
	TYROOL V	FLEXY8	FLEXY5	FLEXY3	SLIMMY	CLAYSTEEL L	CLAYSTEEL S
Height (cm/in)	171/67.32	160/62.99	100/39.37	60/23.62	160/62.99	170,3/67.05	121,2/47.72
Lenght (cm/in)	58/22.83	50/19.68	50/19.68	50/19.68	50/19,68	61,2/24.09	61,2/24.09
Thickness (cm/in)	12/4.72	7/2.76	7/2.76	7/2.76	6/2.36	10,2/4.02	10,2/4.02
Weight (kg/lb)	76/167.55	56/123.46	35/77.16	21/46.30	43/94.80	61/134.48	40/88.18
Power supply	230V 50 Hz						
Maximal power W	1200	490	350	150	490	700	450
Minimal power W	600	-	-	-	-	350	225

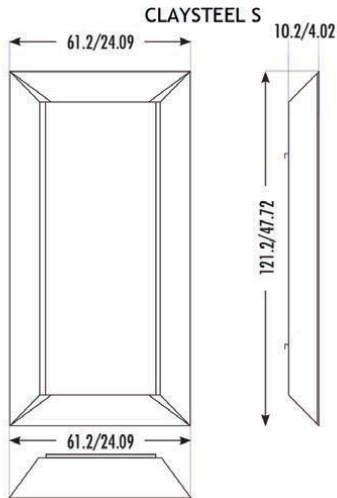
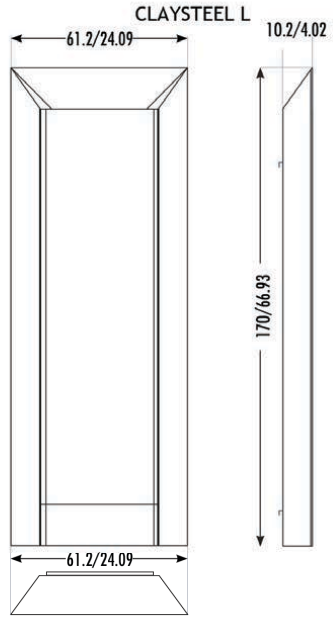
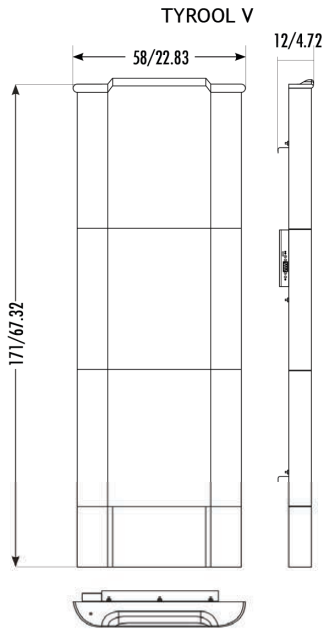

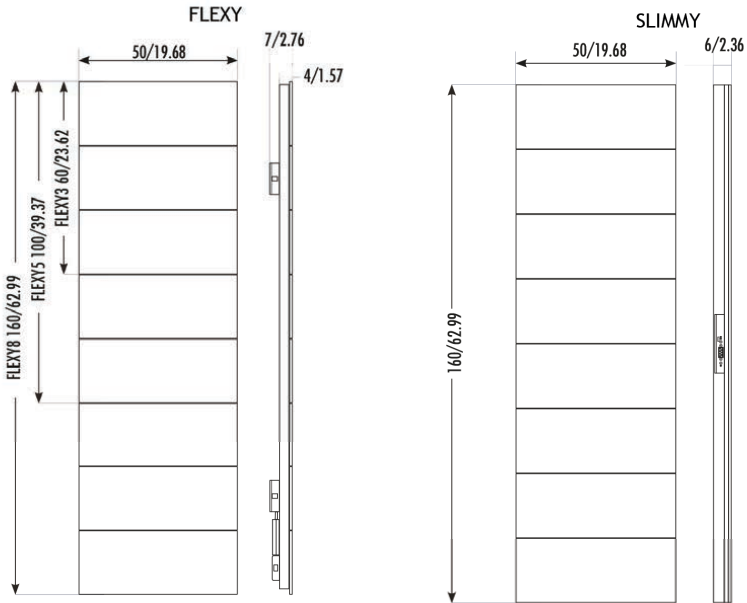

## 3. Package content

The package contains:

- Radiator by Thermal Technology®, including power cable of 1,8 m/70.87 in, 1 pc.
- Wall fixing bracket for radiator, 1 pc.
- Electric power cord of 0,5 m/19.68 in (optional), 1 pc.
- User manual (this document), 1 pc.

## 4. Safety cautions

In this paragraph, you will find rules to be respected for a safety use of your Thermal Technology® radiator.

### 4.1 Installation cautions

Before starting the installation of your radiator, perform the following verifications, respecting the sequence:

1. Package content must correspond with component list mentioned in paragraph 3 of this instruction manual;
2. Verify that the package content, which should not to be damaged during transportation.
3. The voltage of your installation must be the same indicated on the plate with radiator's technical features.
4. Your electric installation must be adapted to the electric power indicated on the plate.

5. If you intend to use several radiators, make sure your electric installation is adapted to the total power of the devices (device's nominal power sum).
6. **POWER CABLE CONNECTION.** If the radiator is the model with cable separately, take the power supply cable from the electric kit and connect it to the radiator, first, and then, when the installation of the radiator is completed, insert it into an electric outlet (you have two cables on your disposition: one of 1,8 m/70.87 in, and another of 0,5 m/19.68 in);





## TYROOL V RADIATOR INSTALLATION EXAMPLE

Open the package and make sure there are electric connection kit, wall fixing bracket, 1 pc, instruction and maintenance manual, and the radiator; choose the place for installation, verify the supporting wall, attention, the radiator must not be installed directly under electric outlet; also, make sure that after installation of the radiator, the plug and the outlet are easy to access.

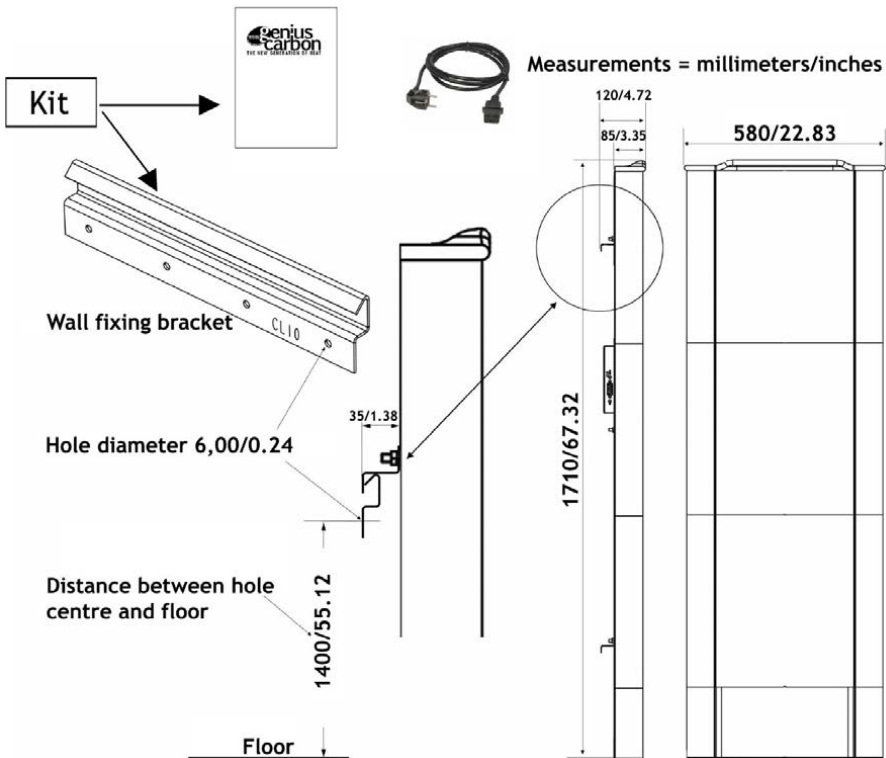

## CLAYSTEEL L RADIATOR INSTALLATION EXAMPLE

Open the package and make sure there are electric connection kit, wall fixing bracket, 1 pc, instruction and maintenance manual, and the radiator.

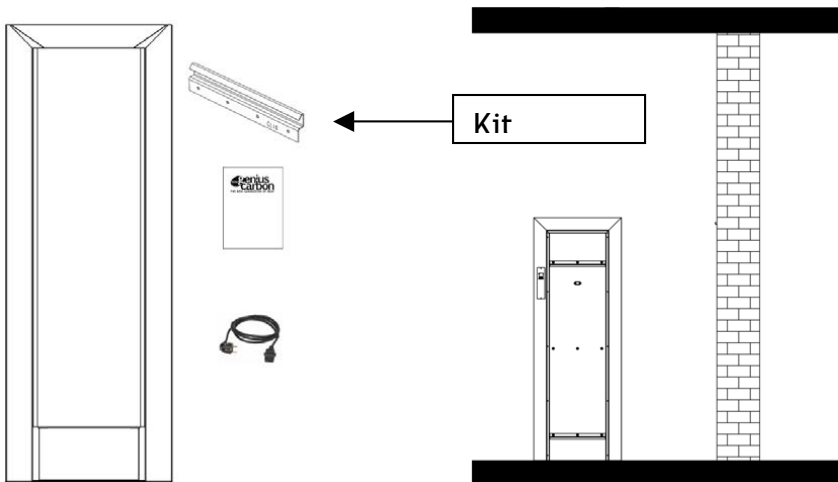

Choose the place for installation, verify the supporting wall, attention, the radiator must not be installed directly under electric outlet; also, make sure that after installation of the radiator, the plug and the outlet are easy to access.

**Fix the bracket on the wall:**  
**1. Lift up the radiator;**

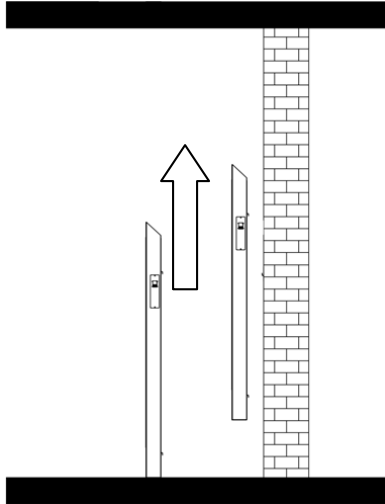

**2. Fit the radiator to the superior bracket;**

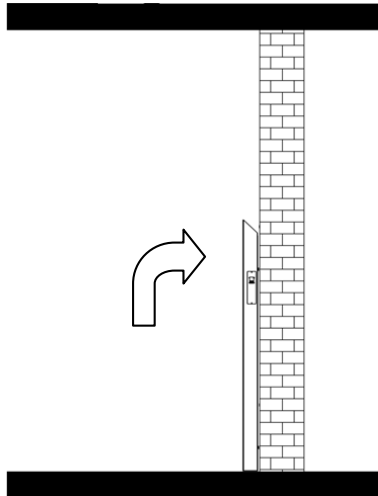

3. Check if the radiator holder has been inserted correctly inside the wall fixed bracket;

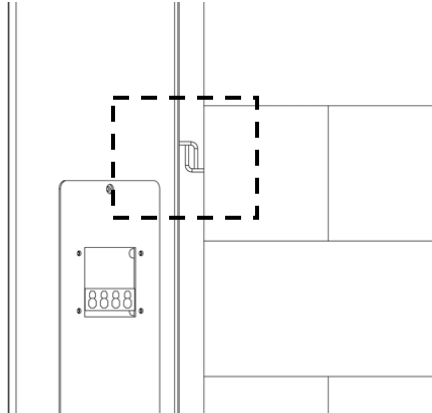

4. Check the correct alignment;

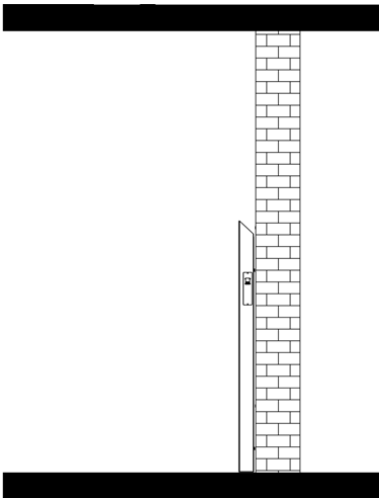

5. Turn on the radiator using the switch on the back, and, for the model with controller, the display on the side;

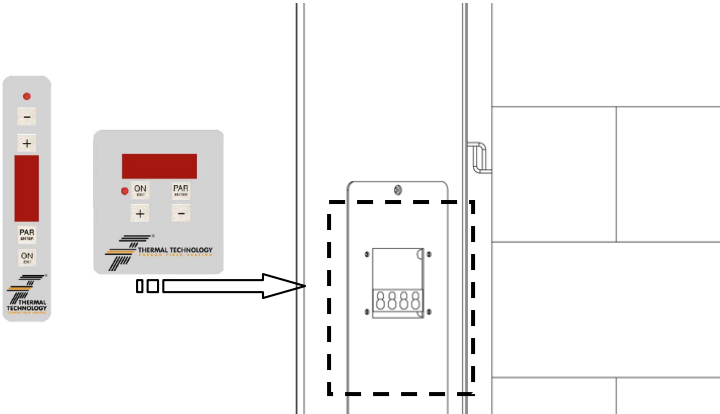

6. Make the necessary setting on the display, as you wish.

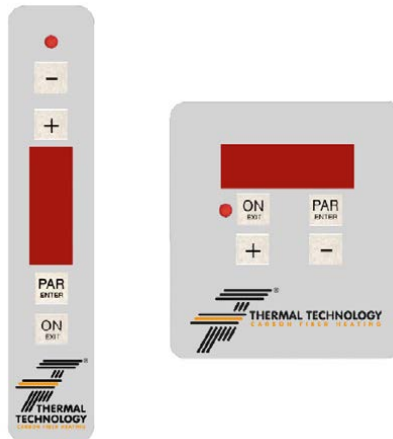

## ATTENTION

Thermal Technology® radiators produce heat, so take into consideration also this feature when choosing its installation point, in particular, make sure that flammable materials are far from radiator. Do not use it in immediate proximity of the bathtub, shower or pull. Do not use this radiator if ceramic tiles are damaged.

## 4.2 User cautions

Thermal Technology® radiators are electric devices, therefore, they must not have contact with water. In order to avoid device overheating, do not cover it with material, cloths, etc.: do not use it for laundry dry! For this purpose it has been applied a warning sign, such as this, which should not be ever removed from the radiator:



Do not lean the power cable on radiator if it is steel hot. If you find any damages of the power cable, contact immediately the specialized assistance center, for its substitution, and do not use the radiator until the cable is replaced. The device must not be used by persons (included children) with physical, sensorial and mental reduced capacities, or with no knowledge or experience, unless they have been given supervision or instruction concerning use of the device from a person responsible for their safety.

## 5. User instructions

### Model with Electronic controller

Insert the plug into the electric outlet and activate the device.

Control unit is equipped with:

- 4 buttons:

**ON** turns ON/OFF the radiator, manually



**PAR** access to the different parameters



**+/-** menu navigation and changing the values



- Four digit display
- Signalisation Led
  - Lighting permanently reports heating in full regime
  - Flashing (1 sec on 1 sec off) reports heating attenuation
  - Flashing (1 sec on 2 sec off) means heat deactivated or radiant plate is hot
  - Led is off means heating is not active because the radiator is turned off, or it reached the desired temperature.

During normal operation, the display shows, cyclically:

**12:06** current time

**17°C** ambience temperature

**ON / OFF** current status ( Activated/Deactivated )



**S. 19°C** setpoint temperature (visible if the radiator is turned On)



## RADIATOR ON/OFF:



Hold  key pressed for a few seconds, if the radiator is off, it will turn on and the control panel will indicate **ON**, if the radiator is on, it will turn off, and the display will indicate **OFF**.

## TEMPERATURE SETTING:

Press  key, the display will indicate **PAR**, then

press  or  buttons, until the warning **TEMP** is displayed, press  to enter temperature parameters settings, then the display will indicate **S. 19°C**

flashing, press  or  keys to set the desired temperature and the



 key for confirmation, and the  key for exit.

## TIME SETTING:

Press  key, the display will indicate the warning **PAR**,

Press  or  keys, until the display will indicate the warning **OROL**, press

 key to temperature parameters settings, the display will indicate an hour, for

ex.: **14:55** flashing, press  key for hour modification, and  key for

minutes setting. Once finished the setting, press the confirmation key  or

 key for exist, without confirmation the modification.





## CLOCK TIMER SETTING:

The controller allows setting of maximum 2 operating intervals, for each of them it is possible to choose the desired temperature.

Press  key, the display will show **PAR**,

press  or  key, until the display will show the wording **CRONO**, press

 key to enter.

By pressing  and  keys, the display will indicate:

**ON 1** setting switch on time for interval 1

**TMP 1** setting the desired temperature for interval 1

**OFF 1** setting switch off time for interval 1

**ON 2** setting switch on time for interval 2

**TMP 2 1** setting the desired temperature for interval 2



**OFF 2** setting switch off time for interval 2



Press  key for parameter access and its setting.

To remove an operation interval, modify the hour until the display will indicate **-- :--** flashing.



**EXAPLE:**



Setting interval 1, starting at 06:00 and finishing at 08:15 with a set point temperature of 20°C.



Press  key, and then the buttons  or  until the display will indicate the wording **CRONO**.

Press again  key. The display will indicate the wording **ON 1**, press  key.

The display will indicate **-- :--** flashing or the activation time set before. By pressing



 and  keys, set the activation time until you see **06:00**, then press

 key, the display will indicate **TMP 1**, press the button , the display will indicate **S. 19°C** flashing.

Using  and  key, set the temperature **S. 20°C**, then press  key.



The display will indicate the wording **OFF 1**, press  key.

The display shows **-- :--** flashing or activation hour set before.

Using  and  keys, set the activation hour **08:15**, and press 



key. The display will show the wording **ON 2** press the  button for exit.

## INTERVAL DEACTIVATION

Press  key. Using the buttons  or  until the display shows

wording **CRONO**, then press  key. The display will show the wording **ON 1**,

press  key. The display will indicate the activation hour set before, press

 key, for hour modification until the display indicates **--:--**, press  key

for confirmation, then  key, for exit.

## Sensor for ambience temperature

Several models are equipped with temperature sensor located on the rear side, downwards. In order to have a more precisely temperature measurement, it is possible to remove the sensor from cable grand and bring it at a distance of 2,00 m/78.74 in far from the radiator heat source. It is also possible to repeat the operation inversely, by pushing the cable back inside the cable grand until reaching the original position.

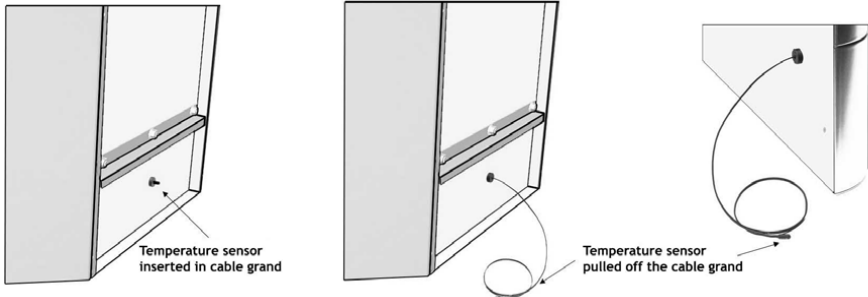

## 6. Maintenance and cleaning

Thermal Technology® electric radiators do not require particular maintenance activities, it is anyway recommended to remove periodically the deposited dust, using a soft and dry cloth.



Before making any maintenance intervention or any other action, proceed as follows: turn off the device, disconnect the plug from the electric outlet, and wait until the radiator is cool.

## 7. Product recycling

Thermal Technology® is electronic equipment and therefore it is disposed separately.

At the end of the life period of the equipment, deliver the product to the appropriate collection centers predisposed in each communal administration, or to the retailers which offer such services.

You also have the opportunity to return the equipment to the distributor when purchasing a new one.

Bear in mind the interdiction of casting the product as municipal waste, you will find under  the product's identification plate the following mark (crossed bin).  Differential casting of electric and electronic equipment is  very important in order to avoid negative consequences on the environment caused by some substances contained in the devices; differential casting consists also of recycling some materials bringing a contribution to the electric energy and natural resources savings.

## 8. Warning

If power supply cable is damaged it must be substituted by the manufacturer or by its technical assistance service, or by the personnel with similar qualifications. In case of installing inside of a bathroom, it must not be installed in places where it could be touched by a person located in a bathtub or shower. In case of installation near a bathtub, shower or sink, it must be respected the distance of at least 60 cm/23.62 in from the various edges.

Under controller box, it is located a temperature sensor, indicating the temperature near the radiator: this sensor DOES NOT measure the real temperature of the room where the radiator is installed, it shows the temperature in radiator vicinity.

## 9. Conformity

This product is manufactured in conformity with the electrical safety standards set by Low Voltage Directive 2014/35/EU. This product is in conformity with Electromagnetic Compatibility Directive 2014/30/EU, concerning the standards for electromagnetic emissions.

## 10. Warranty

Thermal Technology products, manufactured by Carbon Fiber Heating srl benefit of Legal Warranty, established by 1999/44/CE Directive and Commercial Warranty for proper functioning and/or use for entrepreneurial or professional activity.

Thermal Technology by Carbon Fiber Heating srl extends the Warranty for its products, category:

### **RADIATORS FOR A 5 (FIVE) YEARS PERIOD**

of the product, starting with acquisition date. The warranty conditions are exclusively those presented in “FREE CONVENTIONAL/COMMERCIAL WARRANTY”, downloadable from this site:

<http://www.thermaltt.com/>

(section “Download - Warranty”).

In order to benefit of warranty extension it is necessary to register purchased product during 30 (thirty) days, starting with purchase date, on the following web site:

<http://www.thermaltt.com/>

(section “Contacts - Product registration”)

After completing the registration of the requested data, we will process with product serial code control, and after that, you will receive the registration module and warranty extension. The request for product replacement will be sent using the downloadable module, which can be accessed on this site:

<http://www.thermaltt.com/>

(section “Download - Warranty”)

For technical assistance contact:

**Thermal Technology powered by Carbon Fiber Heating SRL**  
**Str Calea Borsului Nr 53B - 410605 Oradea (BH) Romania**  
**Phone: + 40 359 800 893 - Fax: + 40 359 800 894**  
**[www.thermaltt.com](http://www.thermaltt.com) - [info@thermaltt.com](mailto:info@thermaltt.com)**